

# B AC Motors

S.C. Induction Motor 25W (□80mm)

## 25W Speed Control Induction Motor 25W(□80mm)

### Motor Specification

Model 8SDG*-25□: Gear Type Shaft 8SDD*-25: D-Cut Type Shaft	Output W	Voltage V	Frequency Hz	Poles	Duty	Speed Range r/min	Starting Torque		Permissible Torque				Capacitor μF / VAC
							kgfcm	N.m	1200r/min		90r/min		
									kgfcm	N.m	kgfcm	N.m	
8SDGA-25□	25	1φ110	60	4	Cont.	90-1700	1.40	0.140	1.55	0.155	0.70	0.070	6.0 / 250
8SDGD-25□	25	1φ220	60	4	Cont.	90-1700	1.60	0.160	1.80	0.180	0.90	0.090	1.5 / 450
8SDGE-25□	25	1φ220	50	4	Cont.	90-1400	1.00	0.100	1.50	0.150	0.50	0.050	1.3 / 450
		1φ240					1.20	0.120	1.80	0.180	0.50	0.050	

1) Enter the phase & voltage code in the place \* and enter the model type of attaching Gearbox in the box (□) within the motor model name.

2) All models contain a built-in thermal protector.

3) Gear Type Shaft are for attaching Gearbox and D-Cut Type Shaft are for using motor only.

### Speed-Torque Characteristics

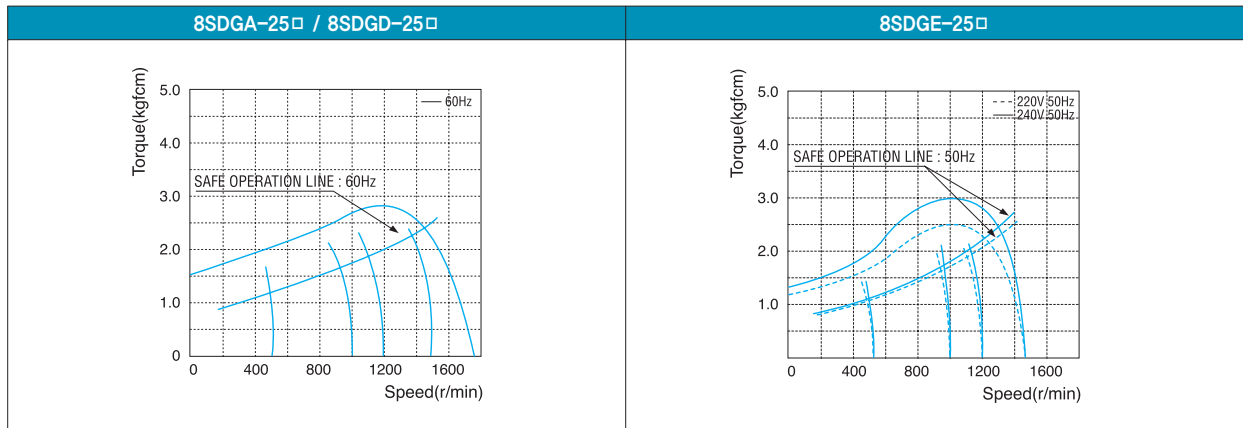

### Max. Permissible Torque at Output Shaft of Gearbox

Motor Model	Gearbox Model	r/min	V	Hz	Gear Ratio	3	3.6	5	6	7.5	9	12.5	15	18	25	30	36	40
8SDG□ -25G	8GBK□BMH	1200	110	60	kgfcm	3.9	4.6	6.4	7.7	9.6	11.6	16.1	19.3	23.2	29.1	34.9	37.9	42.2
				60	N.m	0.38	0.45	0.63	0.76	0.95	1.13	1.58	1.89	2.27	2.85	3.42	3.72	4.13
			220	60	kgfcm	5.8	6.9	9.6	11.5	14.4	17.3	24.0	28.8	34.6	39.2	47.1	46.4	51.6
			50	N.m	0.57	0.68	0.94	1.13	1.41	1.70	2.35	2.83	3.39	3.84	4.61	4.55	5.06	
		220/240	50	kgfcm	4.5	5.4	7.5	9.0	11.2	13.4	18.7	22.4	26.9	33.8	40.5	44.1	49.0	
			50	N.m	0.44	0.53	0.73	0.88	1.10	1.32	1.83	2.20	2.64	3.31	3.97	4.32	4.80	
		90	110	60	kgfcm	1.7	2.1	2.9	3.5	4.4	5.2	7.3	8.7	10.5	13.1	15.8	17.1	19.0
			60	N.m	0.17	0.20	0.28	0.34	0.43	0.51	0.71	0.85	1.02	1.29	1.54	1.68	1.87	
	220		60	kgfcm	2.2	2.7	3.7	4.5	5.6	6.7	9.3	11.2	13.4	16.9	20.3	22.0	24.5	
			50	kgfcm	0.22	0.26	0.37	0.44	0.55	0.66	0.92	1.10	1.32	1.65	1.98	2.16	2.40	
			220/240	50	kgfcm	1.2	1.5	2.1	2.5	3.1	3.7	5.2	6.2	7.5	9.4	11.3	12.2	13.6
				50	N.m	0.12	0.15	0.20	0.24	0.31	0.37	0.51	0.61	0.73	0.92	1.10	1.20	1.33

Motor Model	Gearbox Model	r/min	V	Hz	Gear Ratio	50	60	75	90	100	120	150	180	200	250	300	360	
8SDG□ -25G	8GBK□BMH	1200	110	60	kgfcm	52.7	63.2	79.1	80.0	80.0	80.0	80.0	80.0	80.0	80.0	80.0	80.0	
					N.m	5.16	6.20	7.75	7.84	7.84	7.84	7.84	7.84	7.84	7.84	7.84		
			220	60	kgfcm	64.5	77.4	80.0	80.0	80.0	80.0	80.0	80.0	80.0	80.0	80.0	80.0	80.0
		90	110	60	kgfcm	23.8	28.6	35.7	42.8	47.6	57.1	71.4	80.0	80.0	80.0	80.0	80.0	80.0
					N.m	2.33	2.80	3.50	4.20	4.66	5.60	7.00	7.84	7.84	7.84	7.84	7.84	7.84
			220/240	50	kgfcm	61.2	73.4	80.0	80.0	80.0	80.0	80.0	80.0	80.0	80.0	80.0	80.0	80.0
90	220	60	kgfcm	30.6	36.7	45.9	55.1	61.2	73.4	80.0	80.0	80.0	80.0	80.0	80.0	80.0		
			N.m	3.00	3.60	4.50	5.40	6.00	7.20	7.84	7.84	7.84	7.84	7.84	7.84			
	220/240	50	kgfcm	17.0	20.4	25.5	30.6	34.0	40.8	51.0	61.2	61.0	76.3	80.0	80.0			
N.m	1.67	2.00	2.50	3.00	3.33	4.00	5.00	6.00	6.00	5.98	7.47	7.84	7.84					

Motor Model	Gearbox Model	r/min	V	Hz	Gear Ratio	10	12	15	18	25	30	36	50	60
8SDG□ -25W	8WD□BL/ □BR/□BRL	1200	110	60	kgfcm	12.7	14.9	17.9	20.6	27.1	30.7	35.7	46.5	51.2
					N.m	1.25	1.46	1.75	2.02	2.66	3.01	3.50	4.56	5.01
			220	60	kgfcm	14.9	17.9	22.4	26.9	37.4	44.8	53.8	74.7	81.6
		N.m	1.46	1.76	2.20	2.64	3.66	4.39	5.27	7.32	8.00			
		220/240	50	kgfcm	14.8	17.3	20.8	24.0	31.5	35.6	41.5	54.0	59.4	
		N.m	1.45	1.69	2.04	2.35	3.09	3.49	4.06	5.29	5.82			
		90	110	60	kgfcm	5.7	6.7	8.1	9.3	12.3	13.9	16.1	21.0	23.1
					N.m	0.56	0.66	0.79	0.91	1.20	1.36	1.58	2.06	2.26
			220	60	kgfcm	7.4	8.6	10.4	12.0	15.8	17.8	20.7	27.0	29.7
N.m	0.72	0.85	1.02	1.17	1.54	1.75	2.03	2.65	2.91					
220/240	50	kgfcm	4.1	4.8	5.8	6.7	8.8	9.9	11.5	15.0	16.5			
N.m	0.40	0.47	0.57	0.65	0.86	0.97	1.13	1.47	1.62					

- 1) Enter the phase & voltage code in the box (□) within the motor model name.
- 2) Enter the gear ratio in the box (□) within the Gearbox model name.
- 3) A colored background indicates gear shaft rotation in the same direction as the motor shaft; a white background indicates rotation in the opposite direction.
- 4) The rotating speed is calculated by dividing the motor's synchronous speed (50Hz: 1,500r/min, 60Hz: 1,800r/min) by the gear ratio.  
The actual speed is 2~20% less than the displayed value, depending on the size of the load.

## Dimensions

### MOTOR ONLY

- MOTOR MODEL: 8SDD□-25 (NO FAN)

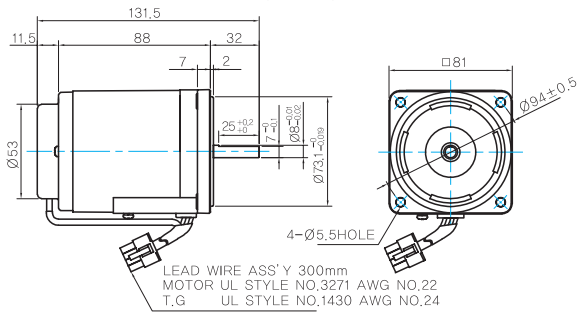

- MOTOR OUTPUT SHAFT

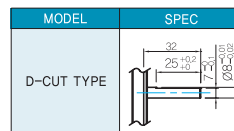

### INTER-DECIMAL GEARBOX

- MODEL: 8XD10□□

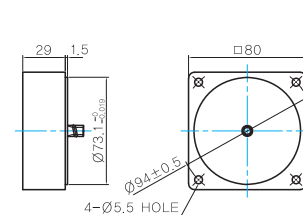

## GEARED MOTOR

### G TYPE GEARBOX

- MOTOR MODEL: 8SDG□-25G (NO FAN)

- GEARBOX MODEL: 8GBK□BMH

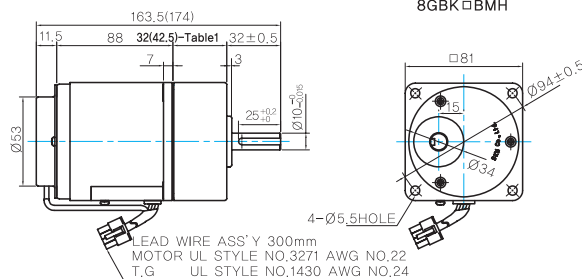

- GEARBOX OUTPUT SHAFT

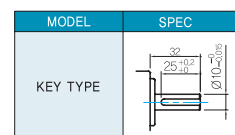

- KEY SPEC

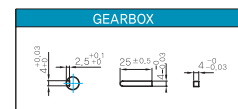

- 32(42.5)-Table1

SIZE(mm)	GEAR RATIO
32	8GBK3BMH - 8GBK18BMH
42.5	8GBK25BMH - 8GBK360BMH

# B AC Motors

## S.C. Induction Motor 25W (□80mm)

### Dimensions

#### W TYPE GEARBOX

MOTOR MODEL:  
8SDG□-25W (NO FAN)

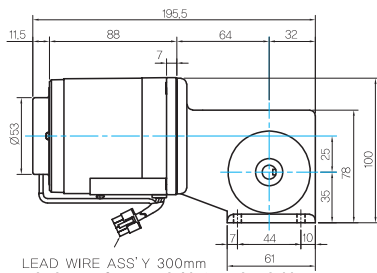

GEARBOX MODEL:  
8WD□BL/BR/BRL

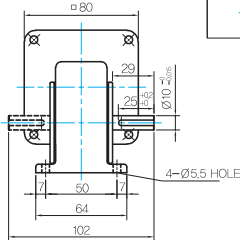

#### KEY SPEC

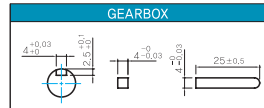

#### WEIGHT

PART	WEIGHT(Kg)	
MOTOR	1.7	
GEAR BOX	8GBK3BMH ~ 8GBK18BMH	0.48
	8GBK25BMH ~ 8GBK30BMH	0.61
	8GBK36BMH ~ 8GBK180BMH	0.67
	8GBK200BMH ~ 8GBK360BMH	0.63
	8WD□BL/BR/BRL	0.67
	8XD10□	0.44

### Motor Images



### Connection Diagrams

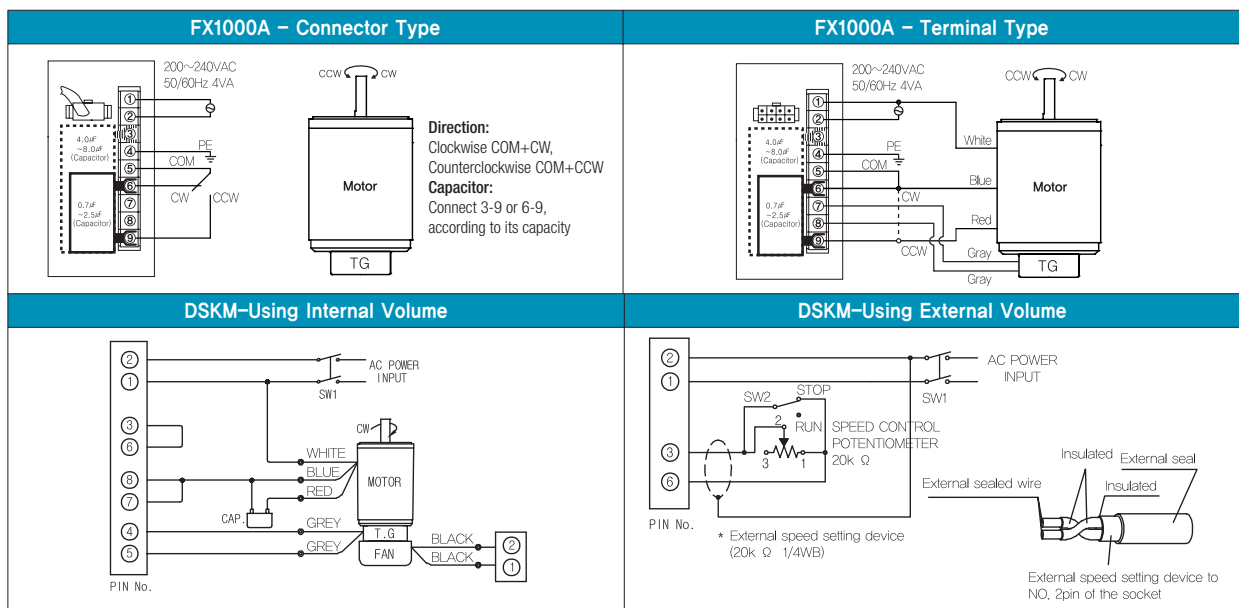

1) At first connect the speed controller with the motor as instructed in connection diagrams. And then input the external power to both of the terminal 'AC' for the rated speed operation.

Now you can adjust the main volume to control the output speed of motor.

2) The direction of motor rotation is as viewed from the shaft end of the motor.

3) CW represents the clockwise direction, while CCW represents the counterclockwise direction.

4) When using powerful fan (F2 type) attached motor, connect two black wires of the fan to No.1 and No.2 terminals in order to supply power.