

B AC Motors

Brake Motor 10W (□70mm)

10W Brake Motor 10W(□70mm)

Motor Specification

Model 7BDG□-10G: Gear Type Shaft 7BDD□-10: D-Cut Type Shaft	Output W	Voltage V	Frequency Hz	Poles	Duty	Starting Torque kgfcm N.m		Rated Load			Capacitor μF / VAC	
								Speed r/min	Current A	Torque kgfcm N.m		
7BDGA-10G	10	1∅110	60	4	30min.	0.83	0.083	1550	0.31	0.70	0.070	3.5 / 250
7BDGD-10G	10	1∅220	60	4	30min.	1.00	0.100	1550	0.20	0.79	0.079	1.2 / 450
7BDGE-10G	10	1∅220	50	4	30min.	0.86	0.086	1250	0.16	0.82	0.082	1.0 / 450
		0.99				0.099	0.18		0.90	0.090		

- 1) Enter the phase & voltage code in the box (□) within the motor model name.
- 2) All models contain a built-in thermal protector.
- 3) Gear Type Shaft is for attaching Gearbox and D-Cut Type Shaft is for using motor only.

Max. Permissible Torque at Output Shaft of Gearbox

60Hz

Motor Model	Gearbox Model	Gear Ratio r/min	3	3.6	6	7.5	9	12.5	15	18	25	30	36	50	60	75	90	100	120	150	180
			7BDG□-10G	7GBK□BMH	kgfcm N.m	600 0.19	500 0.23	300 0.39	240 0.48	200 0.58	144 0.80	120 0.96	100 1.16	72 1.45	60 1.74	50 1.90	36 2.63	30 3.16	24 3.95	20 4.74	18 4.90

50Hz

Motor Model	Gearbox Model	Gear Ratio r/min	3	3.6	6	7.5	9	12.5	15	18	25	30	36	50	60	75	90	100	120	150	180
			7BDG□-10G	7GBK□BMH	kgfcm N.m	500 0.20	416 0.24	250 0.40	200 0.50	166 0.60	120 0.83	100 1.00	83 1.20	60 1.51	50 1.81	41 1.97	30 2.73	25 3.28	20 4.10	16 4.90	15 4.90

- 1) Enter the phase & voltage code in the box (□) within the motor model name.
- 2) Enter the gear ratio in the box (□) within the Gearbox model name.
- 3) A colored background indicates gear shaft rotation in the same direction as the motor shaft; a white background indicates rotation in the opposite direction.
- 4) The rotating speed is calculated by dividing the motor's synchronous speed (50Hz: 1,500r/min, 60Hz: 1,800r/min) by the gear ratio.
The actual speed is 2~20% less than the displayed value, depending on the size of the load.

Dimensions

MOTOR ONLY

- MOTOR MODEL: 7BDD□-10 (NO FAN)

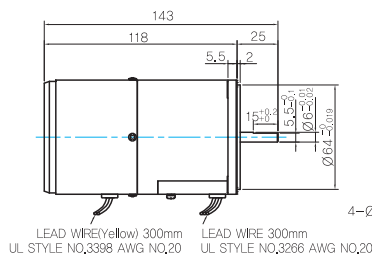

MOTOR OUTPUT SHAFT

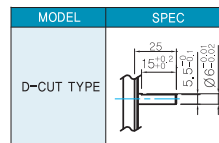

GEARED MOTOR

G TYPE GEARBOX

● MOTOR MODEL:
7BDG□-10G (NO FAN)

● GEARBOX MODEL:
7GBK□BMH

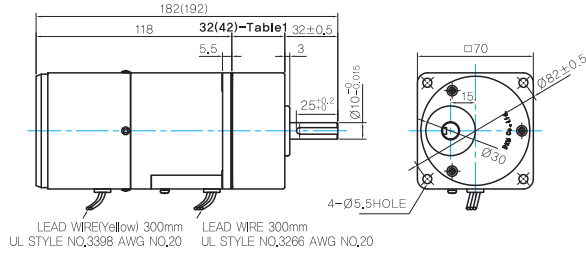

GEARBOX OUTPUT SHAFT

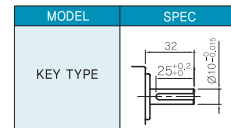

KEY SPEC

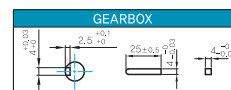

WEIGHT

PART	WEIGHT(Kg)
MOTOR	1.3
GEAR BOX	
7GBK3BMH - 7GBK18BMH	0.36
7GBK25BMH - 7GBK30BMH	0.44
7GBK36BMH - 7GBK180BMH	0.5

32(42)-Table1

SIZE(mm)	GEAR RATIO
32	7GBK3BMH - 7GBK18BMH
42	7GBK25BMH - 7GBK180BMH

Motor Images

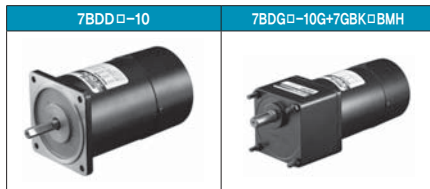

Connection Diagrams

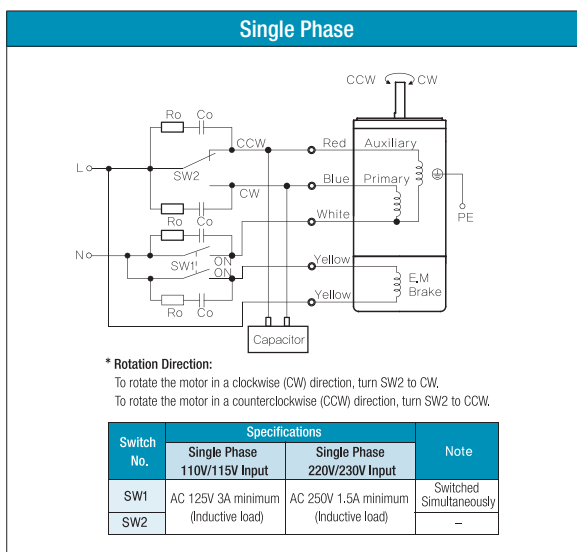

- 1) The direction of motor rotation is as viewed from the shaft end of the motor.
- 2) CW represents the clockwise direction, while CCW represents the counterclockwise direction.
- 3) SW1 operates both motor and electromagnetic brake action.
- 4) The electromagnetic brake will be released and the motor will rotate when SW1 is switched simultaneously to ON. When SW1 is switched simultaneously to OFF, the motor stops immediately with the electromagnetic brake and holds the load.
- 5) If you wish to release the brake while the motor is stopped, apply voltage between the two brake lead wires (yellow).
- 6) Ro and Co indicate CR circuit for surge suppression. [Ro=5~200Ω, Co=0.1~0.2μF, 200WV (400VW)]