

B AC Motors

S.C. Reversible Motor 10W (□70mm)

10W Speed Control Reversible Motor 10W(□70mm)

Motor Specification

Model 7SRDG□-10G: Gear Type Shaft 7SRDD□-10: D-Cut Type Shaft	Output W	Voltage V	Frequency Hz	Poles	Duty	Speed Range r/min	Starting Torque		Permissible Torque				Capacitor μF / VAC
							kgfcm	N.m	1200r/min		90r/min		
									kgfcm	N.m	kgfcm	N.m	
7SRDGA-10G	10	1φ110	60	4	30min.	90-1700	0.60	0.060	0.82	0.082	0.50	0.050	3.5 / 250
7SRDGD-10G	10	1φ220	60	4	30min.	90-1700	0.80	0.080	0.82	0.082	0.50	0.050	1.2 / 450
7SRDGE-10G	10	1φ220	50	4	30min.	90-1400	0.58	0.058	0.70	0.070	0.35	0.035	1.0 / 450
		0.70					0.070	0.75	0.075	0.40	0.040		

- 1) Enter the phase & voltage code in the in the box (□) within the motor model name.
- 2) All models contain a built-in thermal protector.
- 3) Gear Type Shaft are for attaching Gearbox and D-Cut Type Shaft are for using motor only.

Max. Permissible Torque at Output Shaft of Gearbox

Motor Model	Gearbox Model	r/min	V	Hz	Gear Ratio	3	3.6	6	7.5	9	12.5	15	18	25	30	36	50	60	75	90	100	120	150	180			
7SRDG□-10G	7GBK□ BMH	1200	110	60	kgfcm N.m	2.0	2.5	4.1	5.1	6.1	8.5	10.2	12.3	15.4	18.5	20.1	27.9	33.5	41.8	50.0	50.0	50.0	50.0	50.0	50.0		
						0.20	0.24	0.40	0.50	0.60	0.83	1.00	1.20	1.51	1.81	1.97	2.73	3.28	4.10	4.90	4.90	4.90	4.90	4.90	4.90	4.90	4.90
			220	60	kgfcm N.m	2.0	2.5	4.1	5.1	6.1	8.5	10.2	12.3	15.4	18.5	20.1	27.9	33.5	41.8	50.0	50.0	50.0	50.0	50.0	50.0	50.0	50.0
						0.20	0.24	0.40	0.50	0.60	0.83	1.00	1.20	1.51	1.81	1.97	2.73	3.28	4.10	4.90	4.90	4.90	4.90	4.90	4.90	4.90	4.90
			240	50	kgfcm N.m	1.9	2.2	3.7	4.7	5.6	7.8	9.3	11.2	14.1	16.9	18.4	25.5	30.6	38.3	45.9	50.0	50.0	50.0	50.0	50.0	50.0	50.0
						0.18	0.22	0.37	0.46	0.55	0.76	0.92	1.10	1.38	1.65	1.80	2.50	3.00	3.75	4.50	4.90	4.90	4.90	4.90	4.90	4.90	4.90
		90	110	60	kgfcm N.m	1.2	1.5	2.5	3.1	3.7	5.2	6.2	7.5	9.4	11.3	12.2	17.0	20.4	25.5	30.6	34.0	40.8	50.0	50.0	50.0	50.0	50.0
						0.12	0.15	0.24	0.31	0.37	0.51	0.61	0.73	0.92	1.10	1.20	1.67	2.00	2.50	3.00	3.33	4.00	4.90	4.90	4.90	4.90	4.90
			220	60	kgfcm N.m	1.2	1.5	2.5	3.1	3.7	5.2	6.2	7.5	9.4	11.3	12.2	17.0	20.4	25.5	30.6	34.0	40.8	50.0	50.0	50.0	50.0	50.0
						0.12	0.15	0.24	0.31	0.37	0.51	0.61	0.73	0.92	1.10	1.20	1.67	2.00	2.50	3.00	3.33	4.00	4.90	4.90	4.90	4.90	4.90
			240	50	kgfcm N.m	1.0	1.2	2.0	2.5	3.0	4.2	5.0	6.0	8.3	10.0	12.0	16.6	19.9	24.9	29.9	33.2	39.8	49.8	50.0	50.0	50.0	50.0
						0.10	0.12	0.20	0.24	0.29	0.41	0.49	0.59	0.81	0.98	1.17	1.63	1.95	2.44	2.93	3.25	3.90	4.88	4.90	4.90	4.90	4.90

- 1) Enter the phase & voltage code in the box (□) within the motor model name.
- 2) Enter the gear ratio in the box (□) within the Gearbox model name.
- 3) A colored background indicates gear shaft rotation in the same direction as the motor shaft; a white background indicates rotation in the opposite direction.
- 4) The rotating speed is calculated by dividing the motor's synchronous speed (50Hz: 1,500r/min, 60Hz: 1,800r/min) by the gear ratio.
The actual speed is 2-20% less than the displayed value, depending on the size of the load.

Dimensions

MOTOR ONLY

● MOTOR MODEL: 7SRDD□-10 (NO FAN)

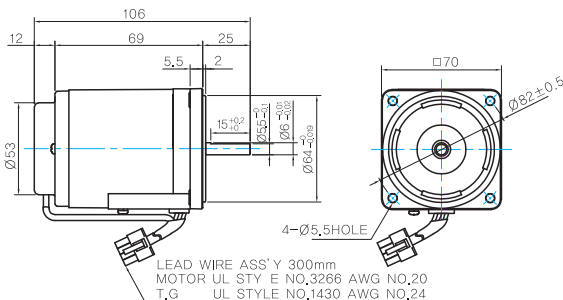

MOTOR OUTPUT SHAFT

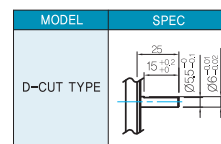

GEARED MOTOR

● G TYPE GEARBOX

● MOTOR MODEL:
7SRDG□-10G (NO FAN)

● GEARBOX MODEL:
7GBK□BMH

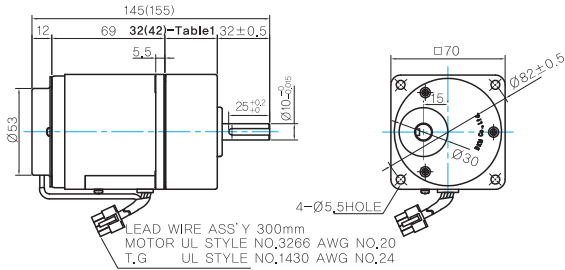

● KEY SPEC

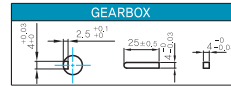

● GEARBOX OUTPUT SHAFT

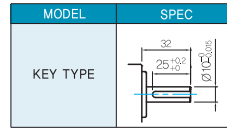

● WEIGHT

PART	WEIGHT(Kg)
MOTOR	0,93
7GBK3BMH - 7GBK18BMH	0,36
7GBK25BMH - 7GBK30BMH	0,44
7GBK36BMH - 7GBK180BMH	0,5

● 32(42)-Table1

SIZE(mm)	GEAR RATIO
32	7GBK3BMH - 7GBK18BMH
42	7GBK25BMH - 7GBK180BMH

Motor Images

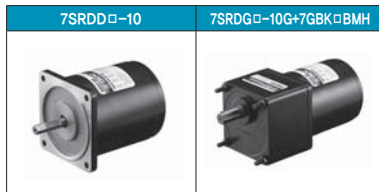

Connection Diagrams

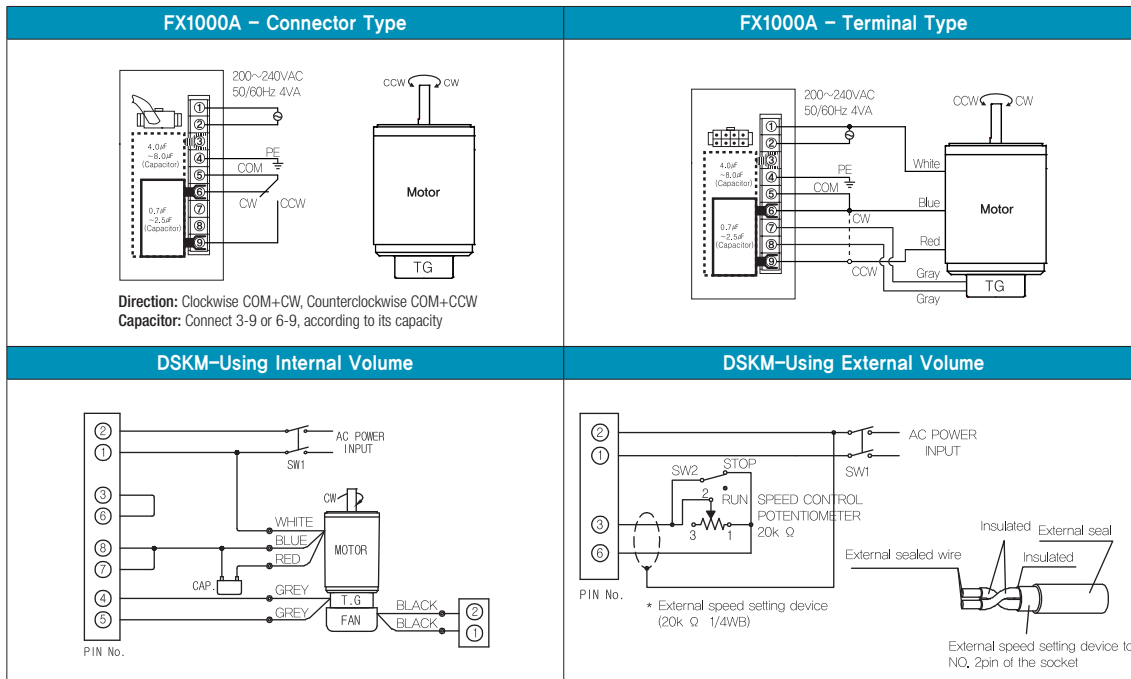

- 1) At first connect the speed controller with the motor as instructed in connection diagrams. And then input the external power to both of the terminal 'AC' for the rated speed operation. Now you can adjust the main volume to control the output speed of motor.
- 2) The direction of motor rotation is as viewed from the shaft end of the motor.
- 3) CW represents the clockwise direction, while CCW represents the counterclockwise direction.
- 4) When using powerful fan (F2 type) attached motor, connect two black wires of the fan to No.1 and No.2 terminals in order to supply power.